

DEMAG

Cranes & Components

Demag drives

Keeping things on the move

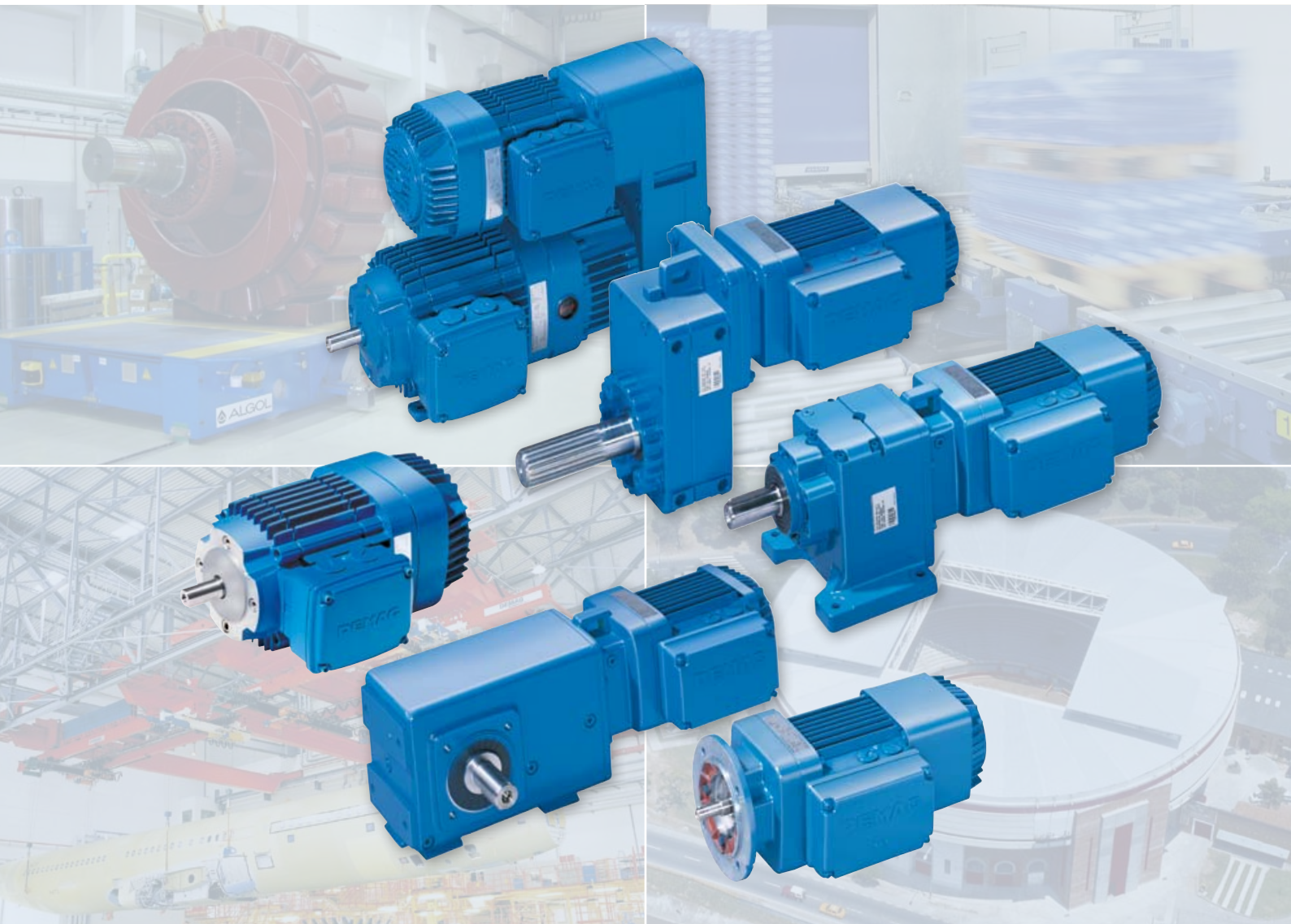

Demag drives make things move from single gearboxes to complete travel units



For cranes and handling equipment

Matching our experience to your application

Demag Cranes & Components provides material flow, logistics and drive solutions of the highest standard and at peak performance rates – for every field of industry and for companies of all sizes – from small workshops to major industrial corporations.

In the interest of our customers, we have applied nearly 200 years of experience in industrial crane manufacture to other applications and made drive technology an integral part of our holistic product philosophy.



For transfer logistics

Wherever you have things to move, you'll find us

At Demag, we supply drive modules from individual sub-assemblies to complete systems and also integrate them in our own system products.

Demag drive technology keeps things moving in almost every field of application – reliable, safe technology that has proven its worth a thousand times over:

- cranes and handling equipment
- transport logistics
- mechanical engineering
- moving architectural elements.



For engineering

One source – countless solutions

As a leading supplier of drive technology, Demag Cranes & Components provides a full product range:

- motors, gearboxes and geared motors
- power supply systems
- frequency inverters
- wheel systems
- complete travel units.

All the individual components are matched to each other because it is only by ensuring perfect interaction between them, and by integrating the intelligent control system, that an efficient overall system can be achieved.



For movable architectural elements

Design is a simple matter – with the right system

Our modular approach enables you to create economical, individual solutions quickly using standardised modules.

This not only saves valuable time at the project planning stage but also ensures the final design is a safe product. You can benefit from our extensive experience and know-how in machines and equipment.

Demag modular drive technology system – a perfect blend of proven components



Frequency inverters

- DeDrive Compact STO – for motor outputs of up to 110 kW
- DeDrive Pro – for motor outputs of up to 560 kW

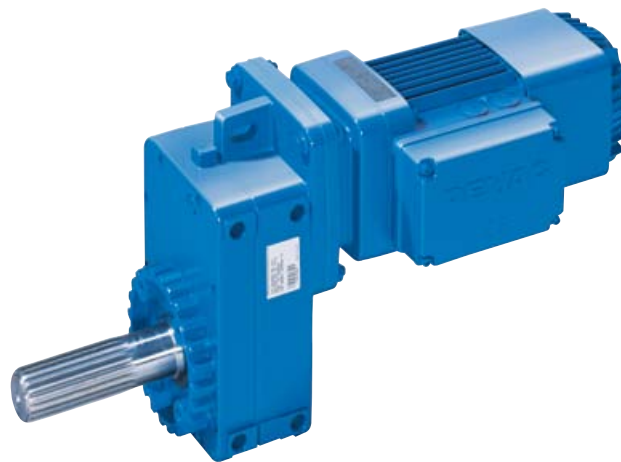

Offset geared motors



Angular geared motors



Project planning tools

- Design software
- Online configuration
- Online ordering system



Microspeed drives



Conical-rotor brake motors

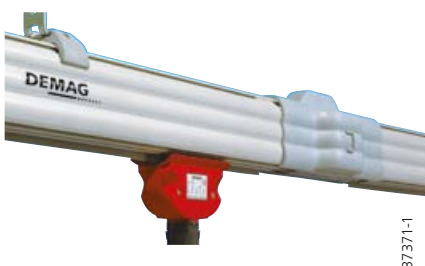

DCL power supply system

- Up to 200 A at 60% CDF
- Up to seven conductors

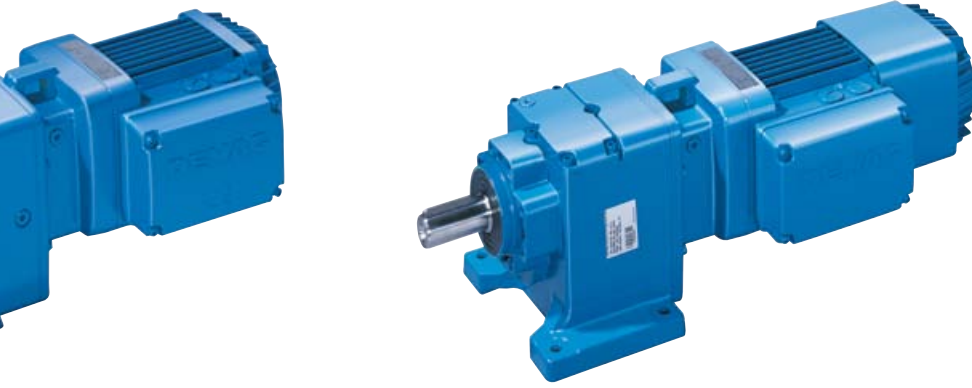

Helical geared motors

Travel unit components

- Wheel loads up to 60 t
- For universal attachment

DRS wheel block system

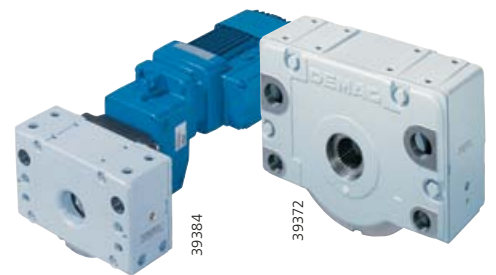

LRS travel wheel system

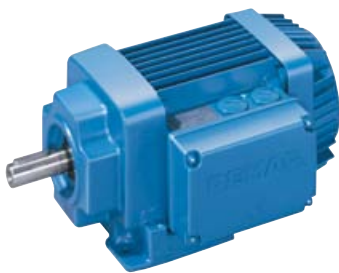
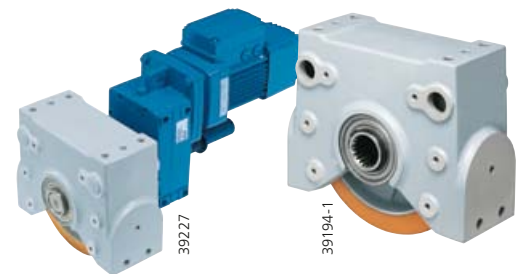

Cylindrical-rotor motors



Cylindrical-rotor brake motors

RS wheel block system

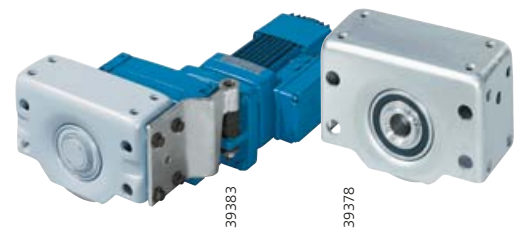

DWS wheel set

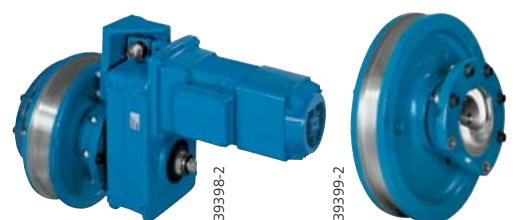

Geared motors – combined strengths

If you are looking for perfectly matched motors and gearboxes, our modular range of units has been designed to meet your requirements:

A-type offset gearboxes	A
W-type angular gearboxes	W
D-type helical gearboxes	D

You can combine these gearboxes with a number of motor units:

Z-type cylindrical-rotor motors	Z
■ With or without a brake	ZB/ZN
■ For general applications	ZBA/ZNA
■ For travel applications	ZBF
■ For continuous duty (energy-efficient motors)	ZBE/ZNE

Conical-rotor brake motors	KB
■ For general applications	KBA
■ For travel applications	KBF

Choose the right brake for the job

To allow you to match the braking torque to the specific application, we have a number of versions to meet your requirements:

- ZB cylindrical-rotor brake motors offering a choice of two different brake sizes
- additional fine-tuning by combining different numbers and types of brake springs
- KB conical-rotor brake motors for cases involving extremely high braking energy and start-stop frequency.

This is how you benefit from FG microspeed units

Our microspeed units make it possible to achieve large mechanical speed ratios of up to 500 : 1 between main and positioning speeds.

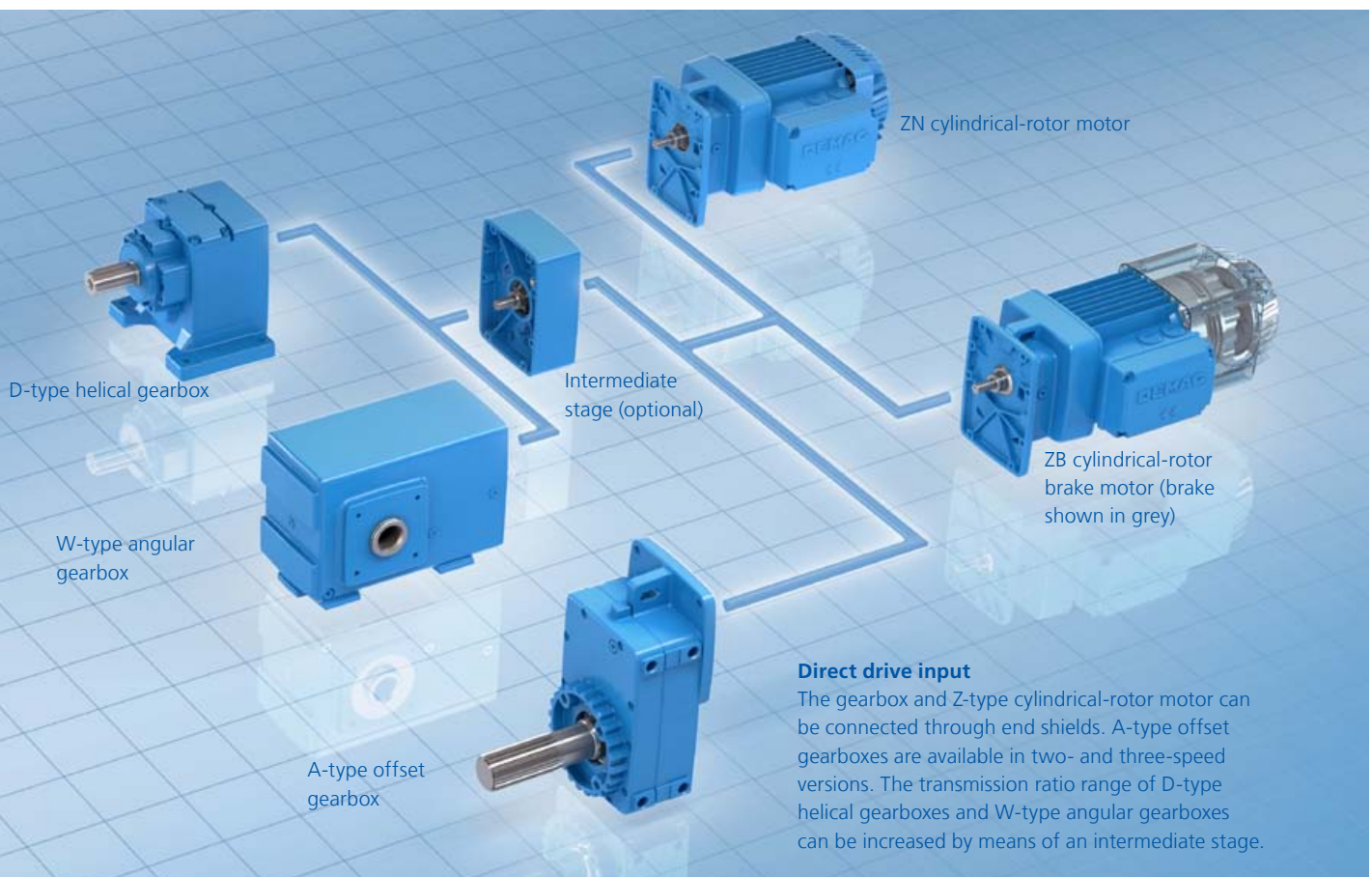

Z	B	A	A	M	E
<p>Z cylindrical-rotor motor K conical-rotor brake motor</p>			<p>A general applications, intermittent duty E continuous duty, efficiency class IE2 F travel applications</p>		
<p>B with integrated brake (ZB, KB) N without a brake (ZN)</p>			<p>U universal mounting G foot mounting F flange-mounting M torque bracket arrangement – splined connection D torque bracket arrangement – bolted flange connection</p>		
			<p>A offset gearbox W angular gearboxes D helical gearboxes</p>		

Simply adapt our technology to your needs

Our modular system is designed to be tailored to the most varied needs. Even the standard versions of these products provide numerous combination possibilities. A wide choice of options and accessories rounds off the range. Mounting variants simplify the task of optimising the design solution. Rotary encoders and temperature detectors enable additional functions to be integrated.

You can count on our support

In addition to offering our modular system, we support our customers with these tools:

- an extensive catalogue of detailed information
- software for calculating drives
- an online tool for configuring your drive solution
- highly dedicated staff to advise you.

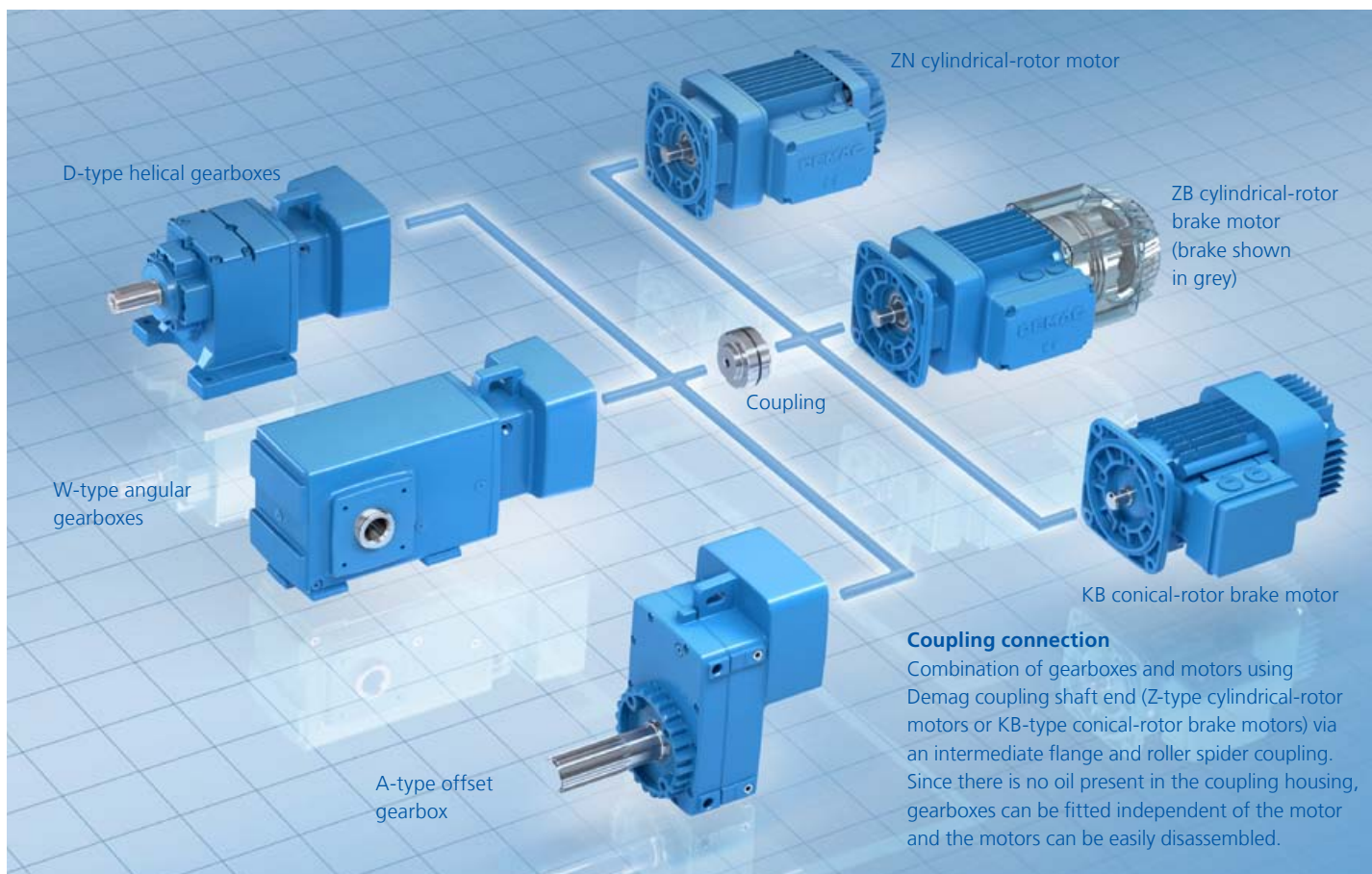

A-type offset gearboxes – the space-saving alternative

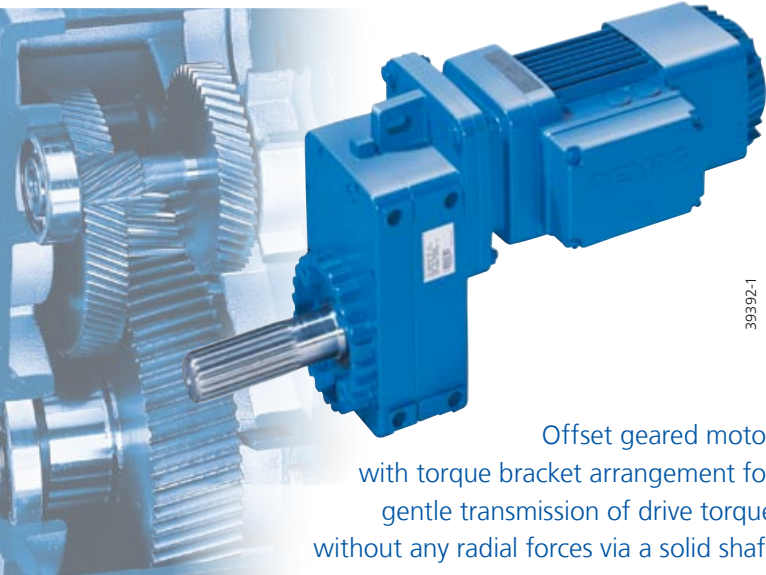

39392-1

Offset geared motor with torque bracket arrangement for gentle transmission of drive torque without any radial forces via a solid shaft with involute splines

If you are looking for space-saving drive units, our A-type offset gearboxes have been designed specifically for that purpose:

- wide range of gear ratios
- economical high-efficiency solutions
- practically orientated design.

Thanks to these characteristics, they have become the preferred choice for many travel applications.

Variable drive output

The possible drive shafts available include:

- solid shaft
 - with a key
 - with involute splines (one or both sides)
- hollow shaft
 - with a key
 - with involute splines
 - with shrink disc.

For torques from 130 to 11,500 Nm

Gearbox size	Output torque [Nm]	Transmission ratio (i)	
		2-stage	3-stage
A10	130	8.32–52.5	–
A20	205	6.21–28.0	31.7–123
A30	370	7.78–71.9	82.4–156
A40	660	8.78–61.6	73.8–256
A50	1,150	8.69–71.6	78.0–218
A60	2,100	8.91–67.9	77.2–297
A70	3,700	9.23–68.1	78.9–267
A80	6,600	9.89–68.9	80.3–281
A90	11,500	10.2–69.7	76.3–274

A10–A40: Aluminium housing

A50–A90: Grey cast housing

For maximum flexibility: 5 housing designs

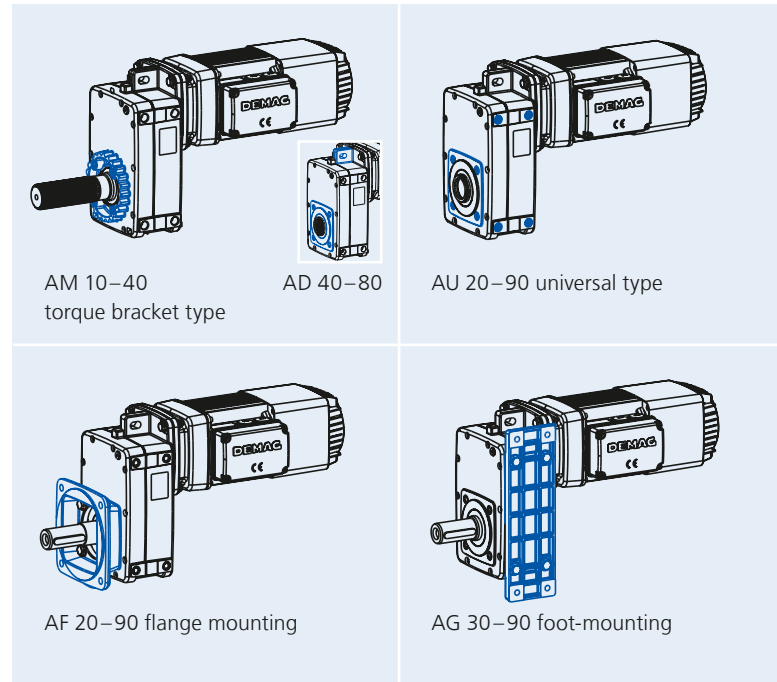

The wide range of housing types available provides plenty of choice for designers

The benefits of design & engineering

Demag offset gearboxes feature large shaft centre distances, which benefits:

- ground-level travel units with large ground clearance
- central drive arrangements with shafts on both sides.

Proven torque transmission method

The AM torque bracket arrangement has been designed as a hollow-shaft gearbox with a torque ring integrated in the housing cover (AM 10–40). This torque ring transmits the drive torque without any radial forces to Demag DRS wheel blocks via a specially designed torque bracket. This sophisticated combination for travel drives with reversing operation is a preferred choice and will benefit your business.

At a glance

- Nine gearbox sizes
- Torques from 130 to 11,500 Nm
- Direct input or coupling connection
- Five housing types
- Five shaft types
- Many more options and accessories (see page 18)

Offset geared motors: seen here as a central drive arrangement with large ground clearance fitted to a tool-changing carriage. These systems are particularly efficient in conjunction with Demag wheel blocks and corresponding torque brackets.

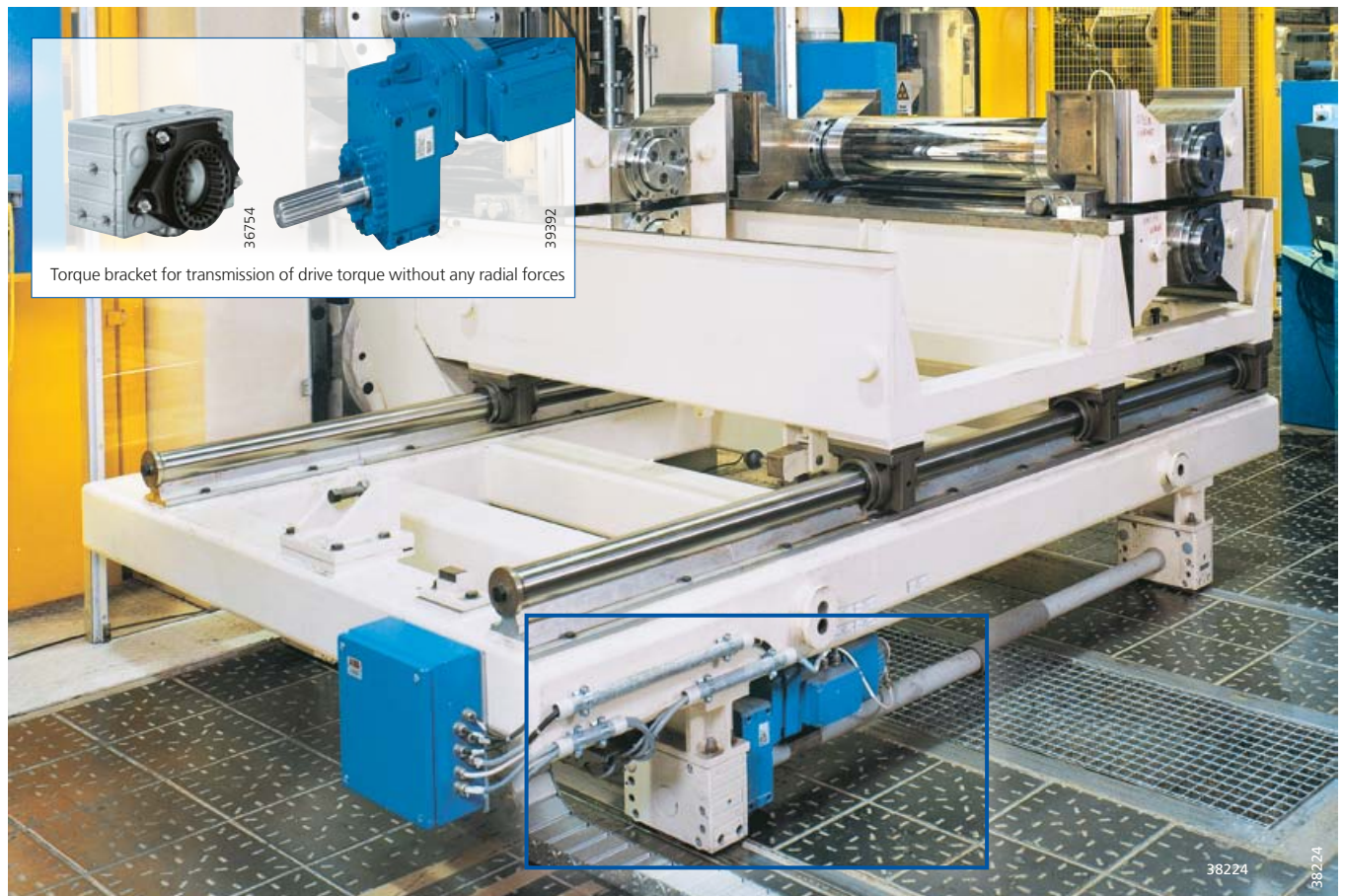

The compact solution – W-type angular gearboxes

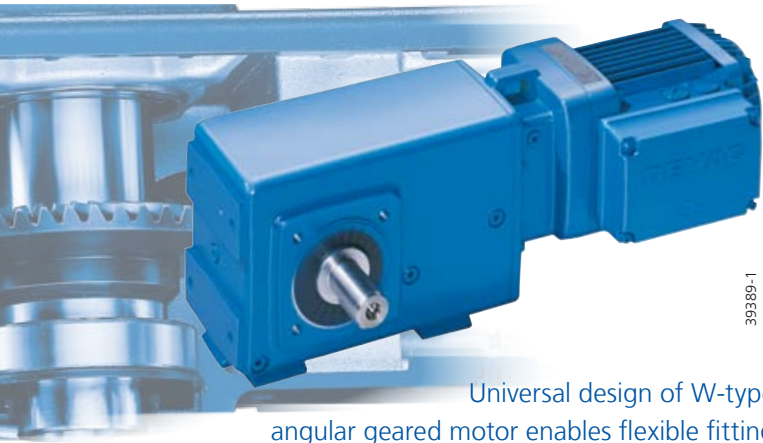

Universal design of W-type angular geared motor enables flexible fitting

39389-1

If you need angular gearboxes to enable very compact designs, our W-type gearboxes are the answer. They enable travel motions to be provided, for example, even when the distance from the rail is very restricted:

- large torques from 120 to 12,000 Nm
- broad range of ratios.

Smooth-running hypoid gearboxes

Sizes W10 to W50 are designed as hypoid gearboxes:

- very smooth running
- large transmission ratio range in hypoid stage.

Highly efficient bevel gearboxes

W60 to W100 gearboxes are all bevel gearboxes:

- excellent efficiency
- three-stage gearing providing high transmission ratios even in the basic versions.

For torques from 120 to 12,000 Nm

Gearbox size	Output torque [Nm]	Transmission ratio (i)		
		2-stage	3-stage	4-stage
W10	120	5.34–100	–	–
W20	200	5.45–90.1	97.1–369	–
W30	330	3.73–90.1	107–369	–
W40	500	3.87–90.8	99.6–371	–
W50	800	4.94–94.3	99.9–386	–
W60	1,350	–	12.6–95.1	113–388
W70	2,500	–	13.7–102	113–399
W80	4,000	–	15.3–113	126–441
W90	7,000	–	15.9–111	126–434
W100	12,000	–	16.5–113	121–485

W10 – W40: Aluminium housing

W50 – W100: Grey cast housing

For maximum flexibility: four housing types

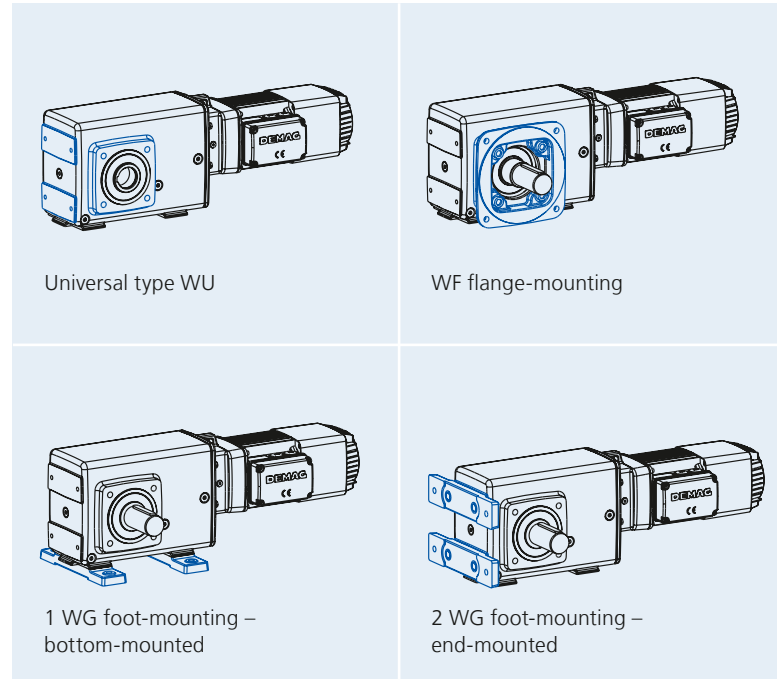

The right fit, always, thanks to various housing types

Variable drive output

The possible drive shafts include:

- Solid shaft
 - with a key (on right/left/both sides)
 - with involute splines (on right/left/both sides)
- Hollow shaft
 - with a key
 - with involute splines
 - with shrink disc.

Versions with shaft ends on one or both sides:

These options make it possible, in combination with the Demag DRS wheel block system, to create solutions with single or central drive arrangements.

At a glance

- Ten gearbox sizes
- Torques from 120 to 12,000 Nm
- W10 – W50 hypoid gearboxes for specially smooth running characteristics
- W60 – W100 bevel-wheel gearboxes, high efficiency rating
- Direct input or coupling connection
- Four housing types
- Five shaft types
- Many more options and accessories (see page 18)

Angular geared motors: particularly suitable for compact drive solutions. The example shows the drives for two conveyor belt chain strands arranged easily side-by-side.

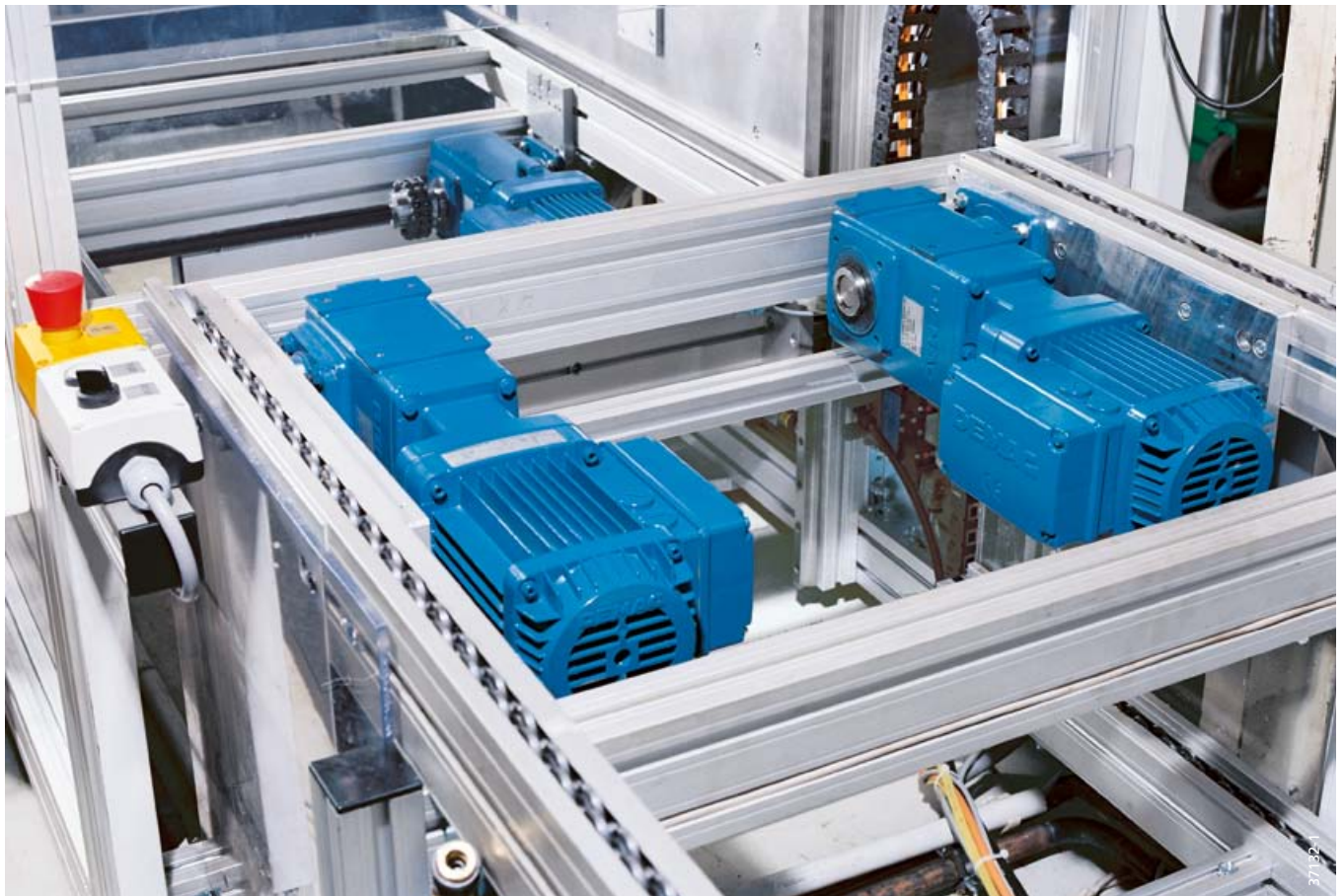

D-type helical gearboxes – the robust ones

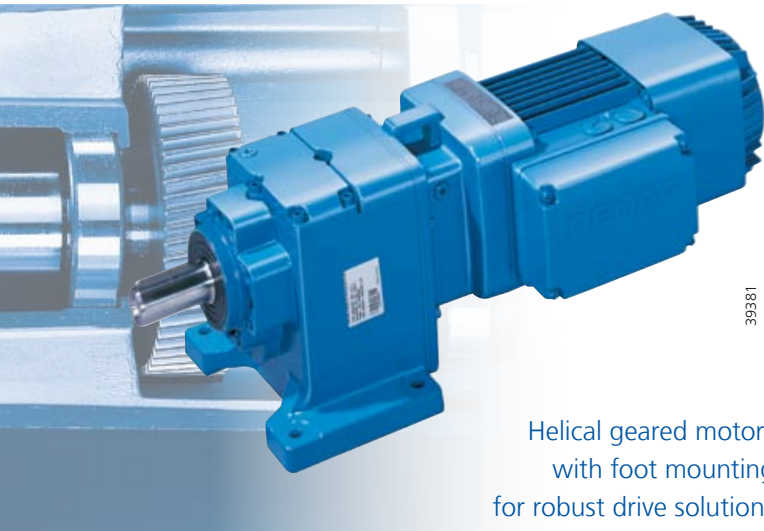

39281

Helical geared motors with foot mounting for robust drive solutions

If you are looking for tough drive solutions, Demag D-type helical gearboxes are known for their resilience:

- torques from 90 to 5,800 Nm
- excellent efficiency rating thanks to helical spur gears
- high radial forces can be applied through the output shaft.

Output – made to measure

The output shaft is a solid shaft with a key, due to the coaxial design of the helical gearbox.

For torques from 90 to 5,800 Nm

Gearbox size	Output torque [Nm]	Transmission ratio (i)	
		2-stage	3-stage
D11	90	2.88–66.5	–
D21	130	2.88–66.5	–
D31	200	3.23–61.6	66.4–253
D41	330	3.23–58.6	49.5–240
D50	550	2.78–61.4	71.9–251
D60	1,000	6.44–48.4	57.5–197
D70	1,800	6.89–51.3	56.7–201
D80	3,200	7.03–49.5	55.5–192
D90	5,800	7.49–51.2	55.1–220

D11 – D41: Aluminium housing

D50 – D90: Grey cast housing

For maximum flexibility: three housing types

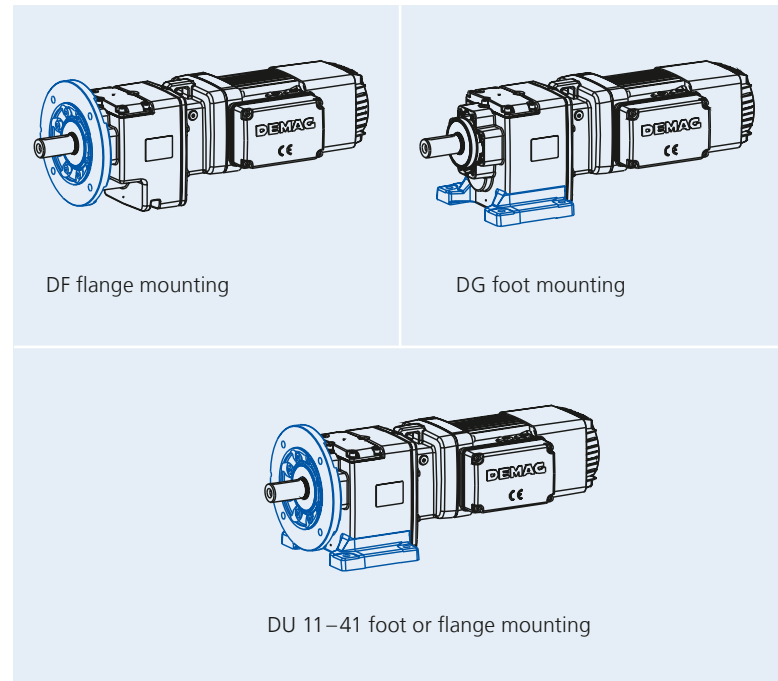

DF flange mounting

DG foot mounting

DU 11–41 foot or flange mounting

Designed for the purpose – different housing types to match your needs

Housing types to match the application

With sizes D11 to D41, it is possible to attach either flanges with internal threads or flanges with through-holes. A further special feature of this size is the combined foot/flange mounting.

At a glance

- Nine gearbox sizes
- Torques from 90 to 5,800 Nm
- Direct input or coupling connection
- Three housing types
- Output via solid shaft with a key
- Many more options and accessories (see page 18)

D-type helical gearboxes: due to their coaxial design, these are the preferred drive option for suspension conveyor systems, such as this one



Z-type cylindrical-rotor motors for universal use

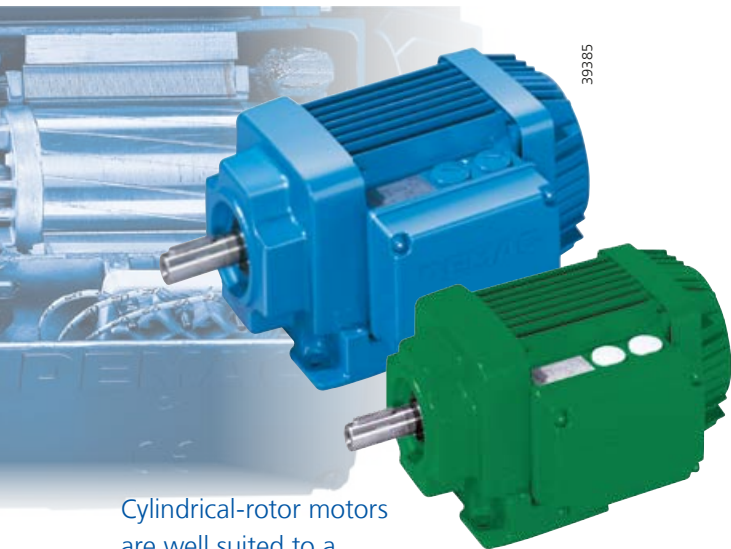

Cylindrical-rotor motors are well suited to a broad range of applications

If you are looking for motors that are able to meet the most varied drive technology needs reliably and efficiently, our Z-type cylindrical-rotor motors offer many advantages:

- perfectly matched to our range of gearboxes
- simple project engineering
- best possible drive efficiency.

Tell us the task in hand – we have the solution

Z-type cylindrical-rotor motors are available with outputs of up to 45 kW:

- 2, 4, 6 and 8 pole (motor efficiency in line with IEC ratings)
- pole-changing with two speeds
- braked (ZB) and unbraked (ZN).

The right cylindrical-rotor motor for your application

- ZBA/ZNA motors for travel applications in conjunction with an inverter
- ZBF motors for line-fed travel applications
- ZBE/ZNE motors for continuous duty in efficiency class IE2.

For outputs of up to 45 kW: four-pole ZBA/ZNA motors

Designation ZBA = braked ZNA = unbraked	Output [kW] 60% CDF 60°C temp.
ZBA/ZNA 63 B4	0.18
ZBA/ZNA 71 A4	0.25
ZBA/ZNA 71 B4	0.37
ZBA/ZNA 80 A4	0.55
ZBA/ZNA 80 B4	0.75
ZBA/ZNA 90 A4	1.1
ZBA/ZNA 90 B4	1.5
ZBA/ZNA 100 AL4	2.2
ZBA/ZNA 100 B4	3
ZBA/ZNA 112 A4	4
ZBA/ZNA 132 AL4	5.5
ZBA/ZNA 132 B4	7.5
ZBA/ZNA 132 C4	9.5
ZBA/ZNA 160 AL4	11
ZBA/ZNA 160 B4	15
ZBA/ZNA 180 A4	18.5
ZBA/ZNA 180 B4	22
ZBA/ZNA 200 A4	30
ZBA/ZNA 225 AL4	37
ZBA/ZNA 225 B4	45

Efficiency ratings in line with IE2: 4-pole ZBE/ZNE motors

Designation ZBE = braked ZNE = unbraked	Output [kW] 100% CDF 40°C temp.	Efficiency rating [%]		
		η_{50}	η_{75}	η_{100}
ZBE/ZNE 80 B4	0.75	79.3	82.2	79.6
ZBE/ZNE 90 A4	1.1	79.8	82.3	81.4
ZBE/ZNE 90 B4	1.5	82.1	83.4	82.8
ZBE/ZNE 100 A4	2.2	83.8	84.9	84.3
ZBE/ZNE 100 B4	3	83.6	86.4	85.5
ZBE/ZNE 112 A4	4	86	87.4	86.6
ZBE/ZNE 132 A4	5.5	87.2	88.3	87.7
ZBE/ZNE 132 B4	7.5	87.5	90.3	88.7
ZBE/ZNE 160 A4	11	89	90.8	89.8
ZBE/ZNE 160 B4	15	89.2	91.8	90.6
ZBE/ZNE 180 A4	18.5	89.3	92.4	91.2
ZBE/ZNE 180 B4	22	89.2	92.3	91.6
ZBE/ZNE 200 A4	30	88.4	92.8	92.3
ZBE/ZNE 225 A4	37	90.8	93.2	92.7
ZBE/ZNE 225 B4	45	92.2	93.5	93.1

Your braking needs – configured to match

Demag ZB cylindrical-rotor brake motors are equipped with disc brakes. When no voltage is applied, the DC brakes are automatically applied by springs.

Optimum adaptation to your application:

- choice of two brake sizes for each motor size
- even finer setting of the brake torque by combining differing brake spring quantities and strengths
- various control modules allow operating times in line with application requirements.

Braking torque can be configured from 0.9 Nm (brake size B003) to 680 Nm (brake size B680).

At a glance

- Motor outputs of up to 45 kW
- Number of poles: 2, 4, 6, 8
- Pole-changing motors with two speeds
- Braked and unbraked
- Braking torques can be configured from 0.9 to 680 Nm
- ZBA/ZNA for travel applications with an inverter, ZBF for line-fed travel motions and ZBE/ZNE for continuous duty
- Many more options and accessories (see page 18)

Line-fed travel applications: 8/2-pole ZBF motors

Designation	Output [kW] 40/40% CDF 40°C temp.
ZBF 63 A 8/2	0.06 / 0.25
ZBF 71 A 8/2	0.09 / 0.34
ZBF 80 A 8/2	0.13 / 0.5
ZBF 90 B 8/2	0.2 / 0.8
ZBF 100 A 8/2	0.29 / 1.2
ZBF 112 A 8/2	0.46 / 1.9
ZBF 132 A 8/2	0.72 / 2.9
ZBF 132 B 8/2	0.88 / 3.5

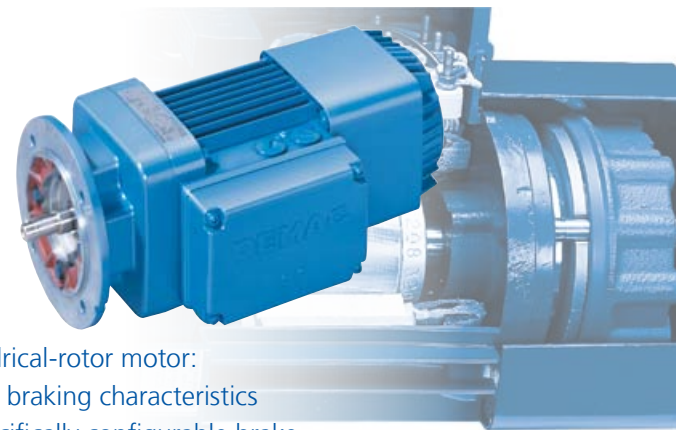

ZB cylindrical-rotor motor:
excellent braking characteristics
with specifically configurable brake

39380-1

KB conical-rotor brake motors – reliable partners

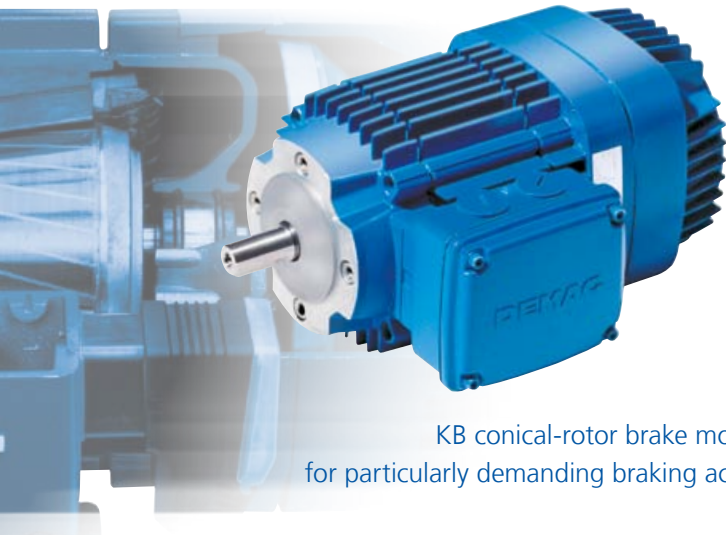

39543-1

KB conical-rotor brake motors for particularly demanding braking action

Demag KB conical-rotor brake motors with outputs of up to 55 kW and a cyclic duration factor of 40% work on a unique braking principle:

- simple
- robust
- reliable.

Simply brilliant – brilliantly simple

The brake is mechanically linked to the rotor. When the motor is switched on, the conical design causes force to be applied in an axial direction, which pulls the rotor towards the drive end together with the brake disk.

The advantage of simplicity

- No switching elements required for the brake: separate controller not needed
- Heat generated during braking is effectively dissipated via the large-format brake cap: longer service lives for the brake linings
- The brake disc is, at the same time, the fan: reduced housing length, good heat dissipation
- Two designs of brake disc: light-weight version for KBA motors, heavy version with increased moment of inertia for KBF motors.

Always the right conical rotor for your application

Alongside the 2, 4, 6 and 8 pole and the pole-changing versions, there are two special KB series:

- KBA for starting/stopping applications with short cycle times
- KBF for line-fed travel motions.

In addition, there is the KBS motor, a version with special windings for standstill operation.

For outputs of up to 55 kW: Four-pole KBA motors

Designation	Output [KW] 40% CDF	Brake torque [Nm]
KBA 71 A4	0.48	6.7
KBA 71 B4	0.72	8.7
KBA 80 A4	1.05	14.5
KBA 80 B4	1.3	17.5
KBA 90 A4	1.65	23
KBA 90 B4	2.0	29
KBA 100 A4	2.4	38
KBA 100 B4	3	48
KBA 112 B4 A	3.6	56
KBA 112 B4	4.5	68
KBA 125 B4 A	6	82
KBA 125 B4	7.4	94
KBA 140 B4 A	9.6	130
KBA 140 B4	11.5	166
KBA 160 B4	20	215
KBA 180 A4	30	335
KBA 200 B4	40	430
KBA 225 B4	55	610

Synchronised action

The brake is released at exactly the moment the motor begins to rotate. When the motor is switched off, the brake is immediately applied.

Superior braking

Our KB motors are the superior choice wherever the highest demands are made on the brake:

- designed for heavy-duty brake operation
- extremely high start-stop frequencies permitted
- resistant to temporary overload.

At a glance

- Motor output up to 55 kW at 40% CDF
- Number of poles: 2, 4, 6, 8
- Pole-changing motors with two speeds
- KBA drives for starting and stopping, KBF for line-fed travel operations
- Many more options and accessories (see page 18)

Line-fed travel applications: 8/2-pole KBF motors

Designation	Output [kW] 40/40% CDF	Brake torque [Nm]
KBF 71 A 8/2	0.04 / 0.2	1.4
KBF 71 B 8/2	0.06 / 0.3	1.6
KBF 80 A 8/2	0.13 / 0.5	3.2
KBF 90 A 8/2	0.2 / 0.8	5.2
KBF 100 A 8/2	0.26 / 1.2	7.0
KBF 112 A 8/2	0.42 / 1.9	11.8
KBF 125 A 8/2	0.65 / 2.9	17
KBF 140 A 8/2	1.1 / 4.5	24.3

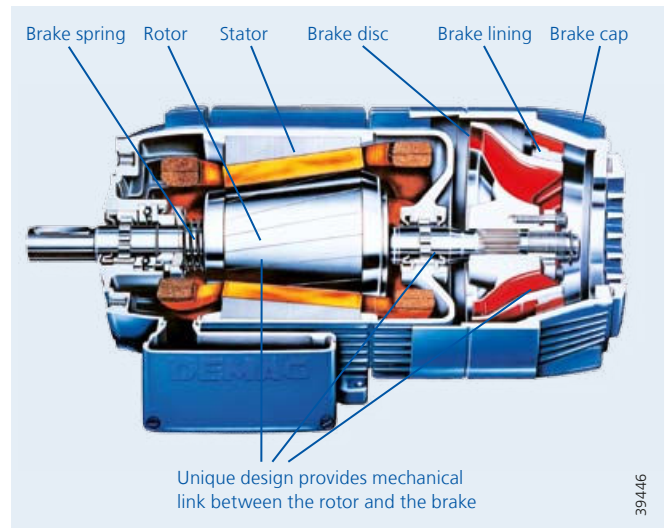

Comprehensive set of features and accessories

If you have a demanding application that needs more, even the standard versions of Demag drive technology products provide the opportunity to tailor functionality to suit specific requirements.

And, if you need a really individual solution, optional features and accessories enable you to match Demag products more closely to your task-specific deployment conditions.

Gearboxes

Options	A offset gearboxes	W angular gearboxes	D helical gearboxes
Torque brackets		■	
Foot rails/foot plates	■	■	
Mounting flange	■	■	■ *
Extended temperature range	■	■	■
Special paint finish	■	■	■
Special lubricants		■	■
Gearbox venting**	■	■	■
Combined gearbox***	■	■	■

* for sizes D11 – D41

** standard from size 50 up

*** for particularly low speeds

Motors

Options	Z cylindrical-rotor motor	KB conical-rotor brake motor
Winding protection		
- PTC thermistor	■	■
- Temperature detector	■	■
Rotary encoders		
- Integrated pulse generator	■	■
- External pulse generator	■	■
- Integrated external pulse generator	■	
Electric plug connection	■	■
Increased ingress protection	■	■
Anti-condensation heater		
- Heating strip	■	■
- Via motor winding	■	
Separately driven fans		
- Built-in separately driven fan	■	
- External separately driven fan	■	■
Heavy fan	■	
Heavy brake disc		■
Protective canopy/plate	■	■

Brakes

Options	Z cylindrical-rotor motor	KB conical-rotor brake motor
Manual brake release	■	■
Brake function monitoring	■	
Brake adjustment monitoring	■	
Sealed/increased ingress protection	■	
Various control modules	■	
Enclosed brake compartment		■
Emergency-stop brake lining	■	



Demag drives – motors for every application

Specially for continuous duty

ZBE/ZNE cylindrical-rotor motors were developed specifically for applications requiring continuous duty. They comply fully with the requirements of efficiency class IE2 as defined in IEC standard 60034.

We keep your mechanisms moving

By far the greater part of all Demag motors sold is used for travel applications and starting and stopping operations. With cyclic duration factors of $\leq 60\%$, they are not affected by the EuP Directive (“Energy Using Products”). Outstanding products suited to these applications are our ZBA/ZNA and ZBF cylindrical-rotor motors and KBA and KBF conical-rotor brake motors.

For standstill operation, there is a version of the starting/stopping solution, the KBS-type is a specially adapted conical-rotor brake motor.



We make drive solutions economical

All Demag motors are designed and manufactured with energy efficiency and cost effectiveness in mind. A decisive factor affecting efficiency and, as a result, cost-aware operation of a drive solution is the way the motor is designed to match the actual travel profile.

Whatever you are looking for – we can offer these solutions:

- the right motor for every application
- support with project drafting
- excellent system solutions using our modular products.

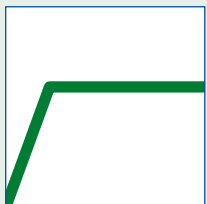
Range of applications for Demag drive technology

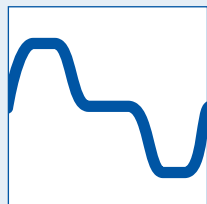
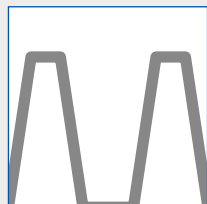
Continuous duty	Travel applications – line-fed	Travel applications – inverter operation	Starting/stopping applications
ZBE/ZNE	ZBF KBF	ZBA/ZNA	KBA
			

Continuous duty – think and act economically

Continuous

ZBE/ZNE motors are unquestionably superior for continuous-duty drive applications. They comply fully with the requirements of efficiency class IE2 as defined in IEC standard 60034.

Efficient

In applications such as continuous conveyors, pumps, fans and compressors, they can produce significant increases in efficiency.

Torque characteristics: standard line-fed applications

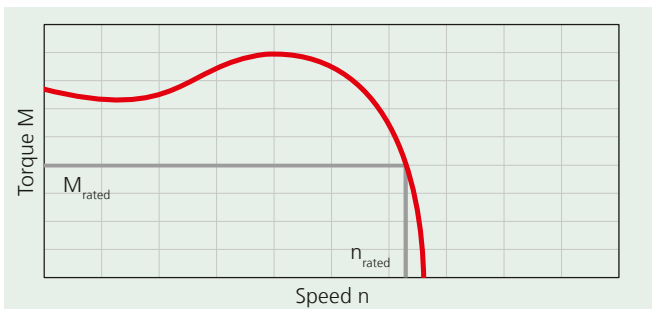

Typical torque characteristic curve for a squirrel cage motor

Speed characteristic curve: continuous duty

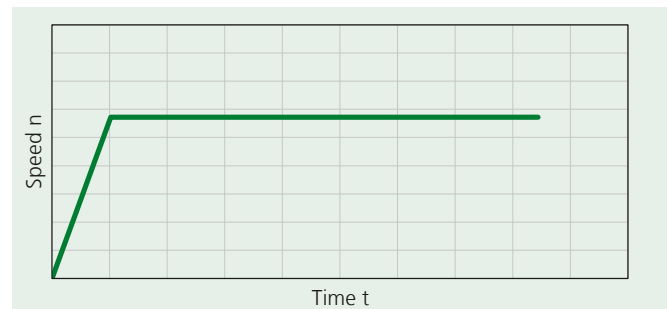

ZBE/ZNE motors are used for continuous duty applications

Continuous conveyors: drive provided by Demag ZBE motors ensures energy-efficient material transport



Line-fed travel applications – gentle acceleration and deceleration

Matched

Demag ZBF and KBF motors are particularly well suited to line-fed travel applications.

Gentle

With their integrated rotating mass, ZBF motors ensure smooth acceleration and deceleration, and the KBF motor accommodates extremely high braking energy.

Torque characteristics: line-fed travel operations

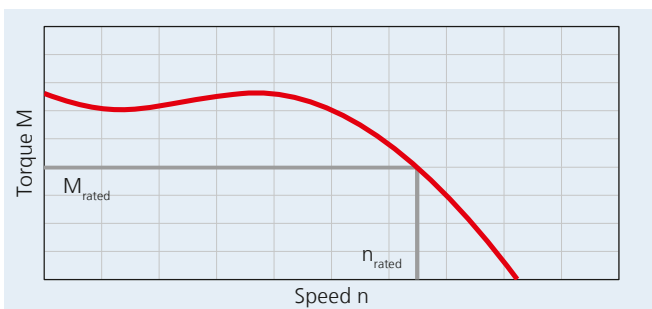

Constant smooth-start characteristics with no excessive starting and breakdown torque

Speed characteristic curve: travel applications for intermittent duty

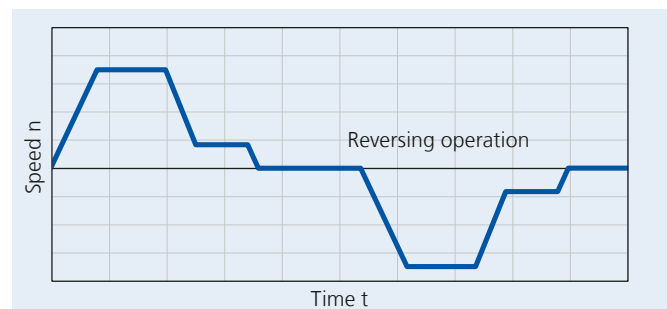

ZBF and KBF motors tend to be used for applications involving reversing duty with creep-positioning speeds.

Tool-changing carriage for a hydraulic press: gentle acceleration and deceleration using a line-fed Demag drive

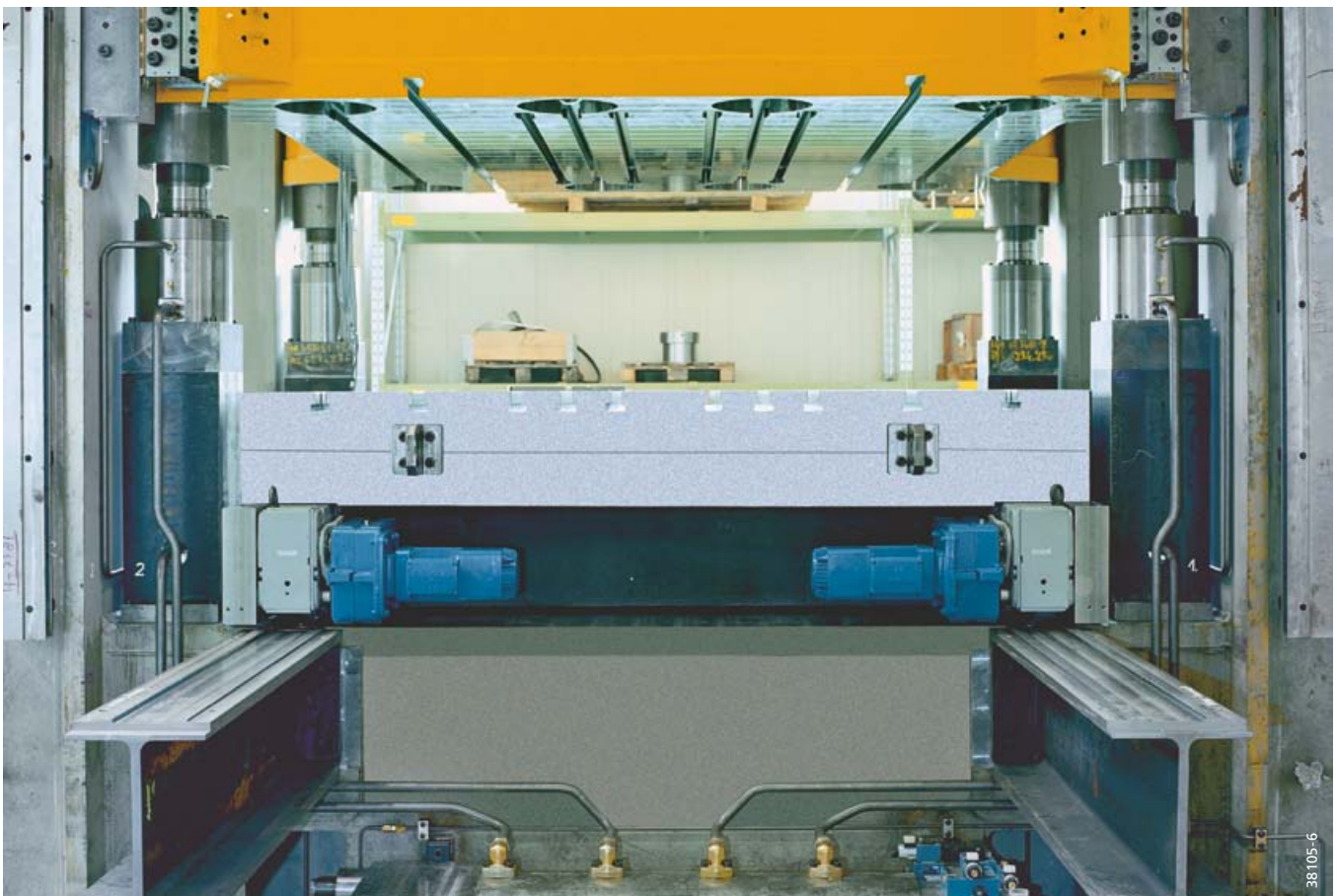

Travel applications with an inverter – dynamic and smooth

Specific

Demag ZBA/ZNA motors have a low internal moment of inertia, which makes them ideal as travel drives in conjunction with a frequency inverter.

Dynamic

Acceleration and deceleration actions are effected highly dynamically but also very smoothly, even in reversing duty.

Torque characteristics: travel with an inverter

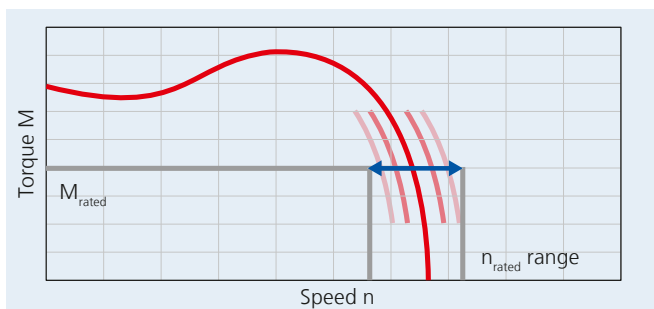

Speed characteristic curve: travel applications for intermittent duty

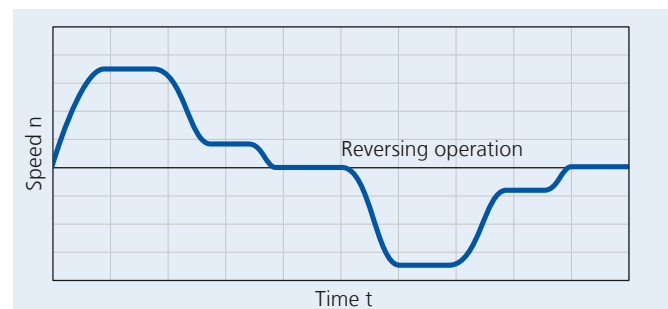

When using an inverter, it is possible to adjust the characteristic curve, which is optimised for travel applications, as required

ZBA/ZNA motors tend to be used for applications involving reversing duty and creep positioning speeds

Concrete hopper: using a Demag travel drive with a frequency inverter to ensure smooth acceleration and deceleration



Starting/stopping operation – exact metering and positioning

Precise

Thanks to their high starting torques, Demag KBA conical-rotor brake motors are ideally suited to starting/stopping applications with short cycle times and high positioning accuracy.

Reliable

KBA motors can be connected direct to a line supply or fed by frequency inverter. In line-fed mode, they are the ideal choice for extremely high start-stop frequencies and robust, allowing brief overloads.

Torque characteristics: drives for starting and stopping

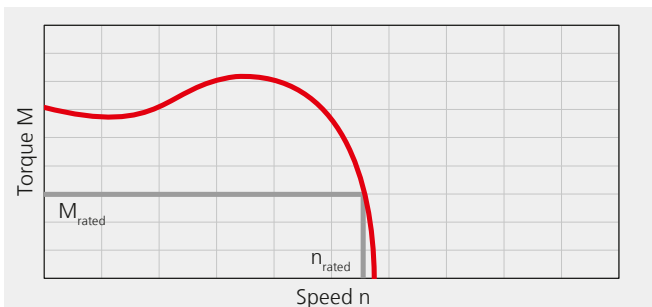

Speed characteristic curve: starting/stopping applications

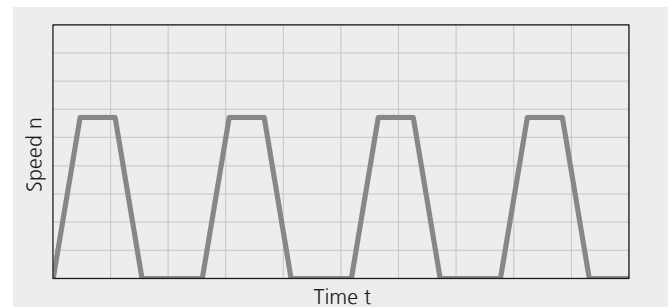

High starting torque for dynamic acceleration

KBA motors are suitable for extremely high start-stop frequencies

Welding line in the automotive industry: here, a KBA conical-rotor brake motor is being used as a microspeed unit, which enables short cycle times and maximum positioning accuracy

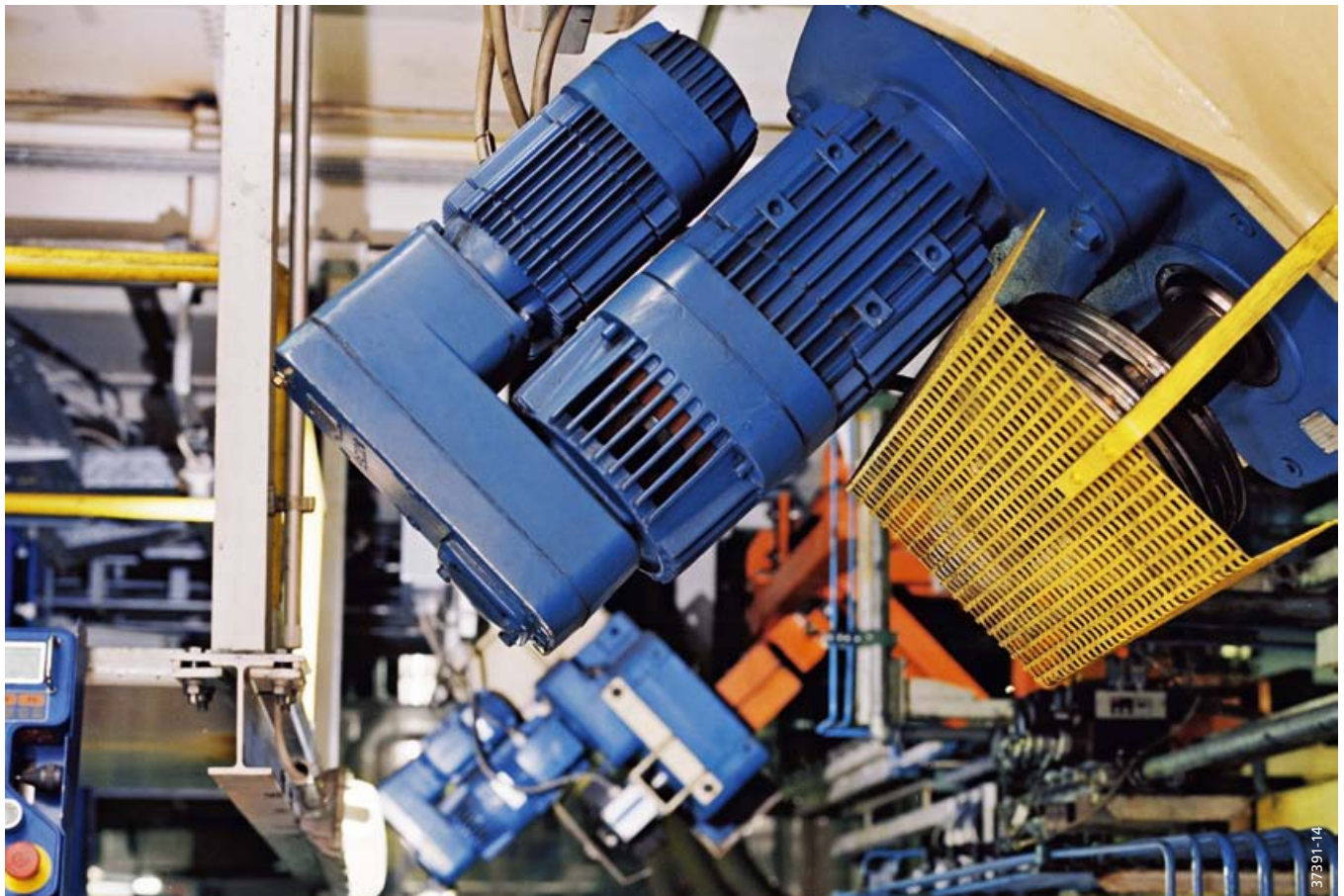

FG microspeed unit – a special case

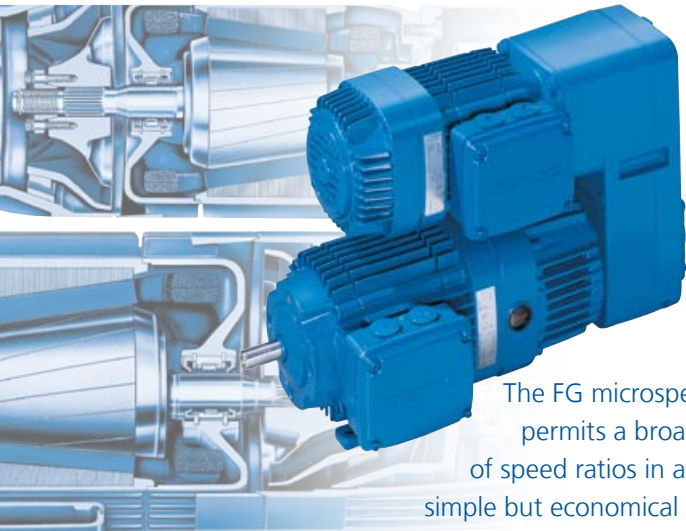

The FG microspeed unit permits a broad range of speed ratios in a robust, simple but economical manner

39388-1

Main and microspeed motor combination

Micro-speed gearbox	Main motor	Microspeed motor							
		KB	71	80	90	100	112	125	140
		Z	63 71	80 90 A	-	90 B 100	-	-	112 132
FG 06	KB 71	■							
	KB 80	■	■						
	KB 90	■	■						
	KB 100	■	○						
	KB 112	■	○						
FG 08	KB 112	■	■	■	■				
	KB 125	■	■	■	■				
	KB 140	■	■	■	○				
	KB 160	■	○	○	○				
FG 10	KB 160	■	■	■	■	■	■	■	■
	KB 180	■	■	■	■	■	■	■	■
	KB 200	■	■	■	■	■	■	■	■
	KB 225	■	■	■	■	■	■	○	

■ = U or Z mounting arrangement

○ = Z mounting arrangement

The alternative

Demag FG microspeed units enable:

- very high positioning accuracy
- high start-stop frequency
- movement of large masses with short cycle times.

Compared to pole-changing motors, Demag FG microspeed drives make it possible to achieve a significantly larger mechanical difference between the main and the positioning speeds. In this simple but effective way, speed ratios up to 500 : 1 can be achieved.

Benefits

FG drives react much less sensitively to

- impacts
- increased ambient temperatures
- other ambient influences

than electronically equipped drives. For many applications, this makes them the simple, robust and economical alternative to inverter-fed AC motors.

Extremely flexible: speed ratios of up to 500 : 1

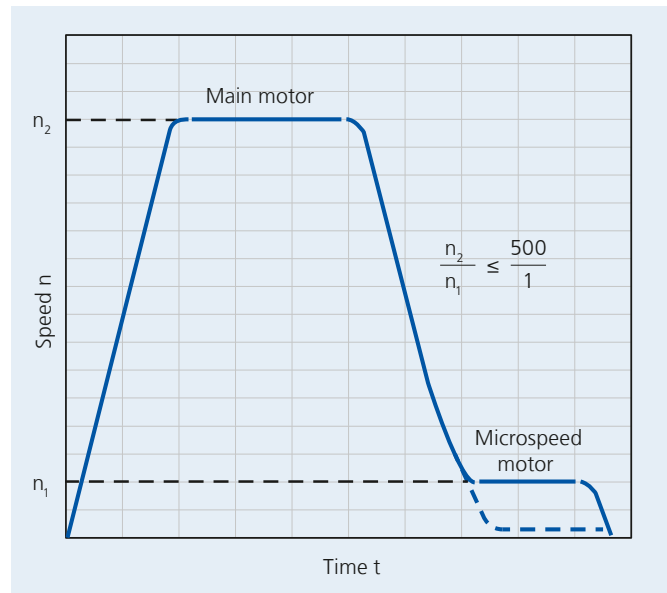

By selecting the right combination of motor and gearbox, the speed ratio can be set within a broad range

The design principle

FG microspeed units consist of one main and one positioning motor linked together by a mechanical microspeed gearbox. The output shaft runs either at the speed of the main motor or at the speed of the microspeed motor reduced by the transmission ratio of the intermediate gearbox.

The main motor is a conical-rotor brake motor – due to the axial motion of the rotor. The brake of the main motor also has the function of a clutch. The microspeed motor can be a KB or a Z motor – also for inverter operation.

The transmission ratios of the microspeed gearbox are available at fine increments from 4 to 125. So by selecting the right combination of motor speeds, you can determine the overall transmission ratios.

FG microspeed unit – simply a good choice

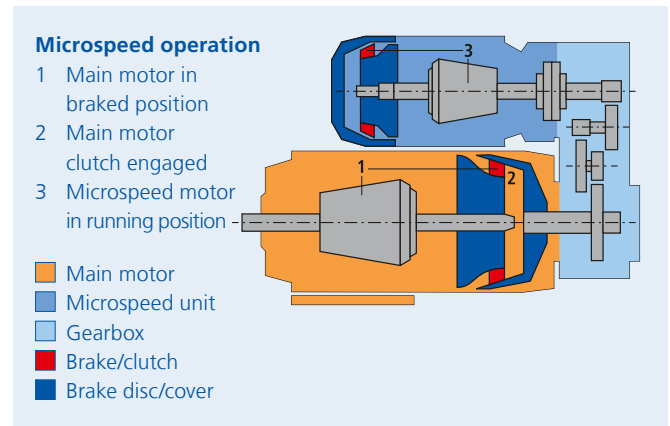

FG microspeed units: robust, powerful, accurate – shown here is a cutting line in the timber industry



Tools and services – your contact with us



If you are looking for a partner to provide you with advice and assistance, we will be pleased to assist, whatever the type of drive solution you are developing. From your desk, you can access the tools we have made available.

Geared motor catalogue – open for your needs

This catalogue presents our entire range of geared motors in detail on over 400 pages.

Take advantage of the selection tables to find detailed technical specifications and add optional equipment and accessories.

We will be pleased to support you with comprehensive tools for planning and design



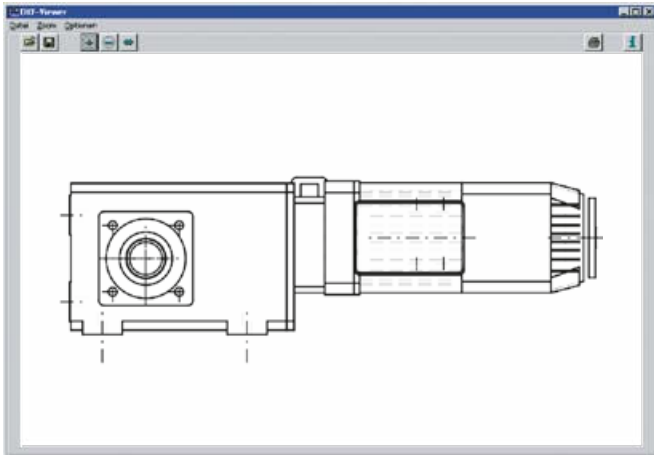

Individual 2D CAD files

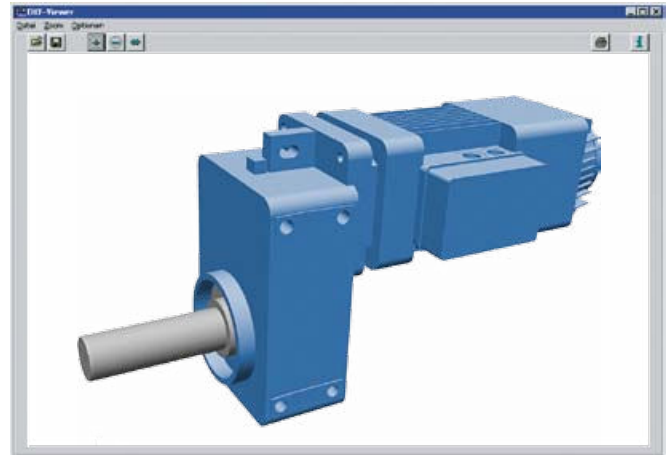

3D product geometries

Drive Designer – open for your ideas

Use the Drive Designer to configure geared motors and wheel systems online. You can quickly:

- select and configure drives
- transfer drawings to your design
- view electrical circuit diagrams
- download the drives' technical data.

Drive Designer provides a high degree of convenience:

- design support with 2D and 3D geometries in all standard data formats
- rapid access to technical specifications
- circuit diagrams for the motors you select
- display of delivery times
- transmit your selection to the Demag Shop system.

www.drives.demag-designer.com

CalDrive – open for your demands

You can use the CalDrive software to calculate suitable drives from the physical parameters you enter. The basic characteristics and data of Demag geared motors and wheel blocks are included in CalDrive. Based on these details, CalDrive will suggest a number of possible solutions for combining the components. The CalDrive software is available at no charge from the internet.

www.drives.demagcranes.com

Demag Shop – open for business

After registering online, you will be sent the access details for the Demag Shop system. In the Shop, you will find the

- prices
- delivery availability
- delivery times

relating to the products you need. Order direct and arrange delivery times and shipping method – provided the parts are in stock. You are immediately sent an order confirmation with our order number.

You can, of course, also use the parcel tracking system online in the Demag Shop even if you order the conventional way.

www.demag-shop.de

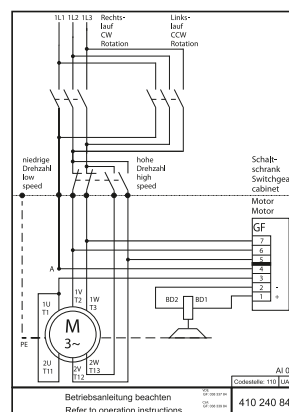

Circuit diagrams are also generated by the Drive Designer

